

Toilet seat O.novo

Model — 9M38S101 O.novo toilet seat with Soft Closing and Quick Release, incl. 9224 17 61 hinge

Product Description — O.novo toilet seat in Wrap Over design made of colour ingrained duroplast with hinges in stainless steel and plastic

- incl. hinge with Quick Release in stainless steel and nylon
- centre distance: 155 mm
- load of ring seat: 250 kg
- 3 years guarantee

Colour Programme — 01 White

Hinge Finish — 61 Stainless steel

Spare Parts — A) 9224 17 61 Hinge with Quick Release in stainless steel and nylon
 B) 9224 21 01 Buffer for seat and cover
 C) 9224 24 00 Soft Closing packet

Cleaning Instructions — Use a mild soap solution. Seat and hinges should not be left damp, but be dried with a soft cloth. When using abrasive, corrosive or chlorine based cleaners for the bowl, avoid contact with seat and hinges as it may lead to damages or flash rust. Therefore, when cleaning the bowl, make sure that seat and cover are in an upright position until all the cleaner has been flushed away.

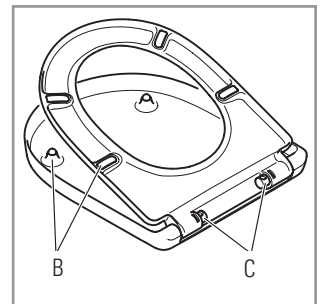
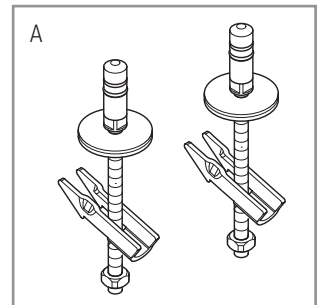
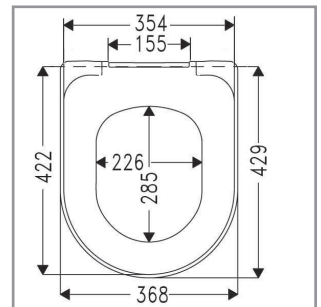

Villeroy & Boch

1748

Installation Instructions

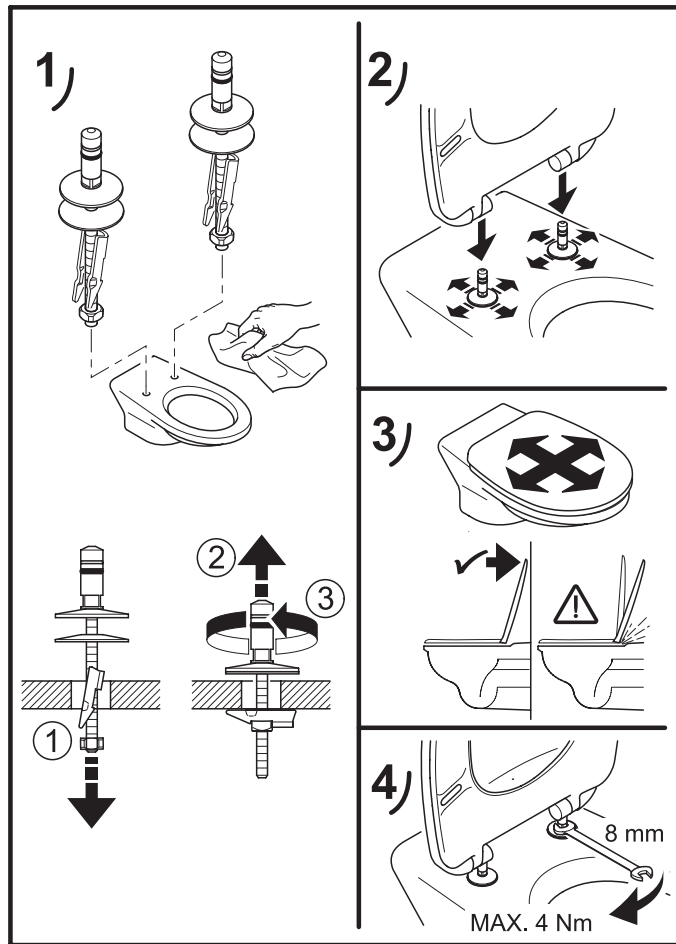

Material Description

TOILET SEAT: The material is colour ingrained duroplast (UF A 10 = urea formaldehyde) that contains no environmentally hazardous substances. UF plastic comprises 67% urea formaldehyde resin, 28% cellulose, as well as 5% minerals, pigments, lubricants and moisture content. The raw material from the supplier contains < 0.03% free formaldehyde and even less following curing.

BUFFERS: PE (Polyethylene)

DAMPER KIT: Hydraulic damper with stainless steel damper casing and plastic parts

DAMPER LIQUID: Anti-friction liquid

HINGES: Stainless steel and nylon

Guarantee

The guarantee includes faults or defects in the material of our products within a period of 3 years. Products subject to minor technical modifications and design deviations E. & O.E.